

Cooling Units for Outdoor Cabinet Unit Assembly Instructions

# 户外柜制冷机安装说明书

## (TCS系列产品)

TCS320  
TCS500  
TCS680  
TCS825  
TCS1100  
TCS1500  
TCS2000  
TCS2500  
TCS3200  
TCS3600



# 中文

## 内容

1. 应用场合
2. 技术参数、安装开孔图
3. 安装方式
4. 安全与注意
5. 电气连接
6. 操作说明
7. 工作原理
8. 维护保养
9. 质量保证
10. 电气原理图
11. 常见故障分析及解决措施

## 1. 应用场合

雷子克 TCS 系列制冷机的产品设计专为户外的控制柜使用！

TCS 系列制冷机是通过把控制柜内的热量驱散出柜外以保护对温度敏感的组件。TCS 系列制冷机是特别适合温度在0°C至55°C范围内使用，可以达到其它散热产品如空气/空气热交换器、风扇和过滤器单元达不到的效果。

## 2. 技术参数

项目	TCS320				TCS500			
	TCS320/320-V		TCS320Q/320Q-V		TCS500/500-V		TCS500Q/500Q-V	
订货号	30200358	30200382	30200583	30200593	30200579	30200581	30200584	30200594
制冷功率W ( L35L35 )	320				500			
制冷功率W ( L35L50 )	240				400			
消耗功率W ( L35L35 )	240				300			
消耗功率W ( L35L50 )	270				340			
冷媒	R134a/360g							
机组运行环境温度°C	0-55							
额定电压V	230							
额定频率Hz	50Hz							
电压范围V	220-240							
换气功能	可选 (注：产品型号后带“-V”的表示该产品有换气功能)							
外形尺寸WxHxDmm	300x560x155							
重量Kg	16				18			
防护等级	IP54							
噪音等级	52dB(A)							
安装方式	半内嵌安装	无螺钉卡装	半内嵌安装	无螺钉卡装	半内嵌安装	无螺钉卡装	半内嵌安装	无螺钉卡装

TCS320/500/320Q/500Q外形图:

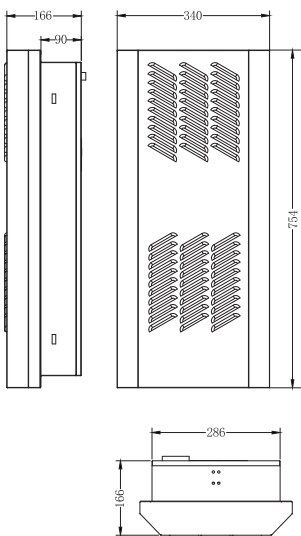

TCS320/500  
安装开孔图:

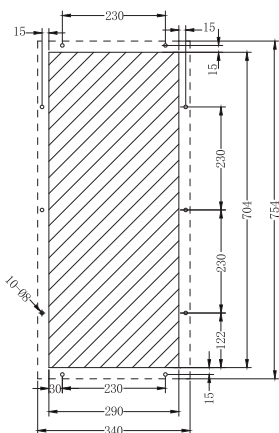

TCS320Q/500Q  
安装开孔图:

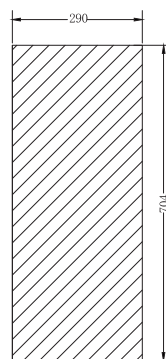

项目	TCS680				TCS825			
	TCS680/680-V		TCS680Q/680Q-V		TCS825/825-V		TCS825Q/825Q-V	
订货号	30200357	30200393	30200585	30200595	30200572	30200573	30200586	30200596
制冷功率W ( L35L35 )	680				825			
制冷功率W ( L35L50 )	560				680			
消耗功率W ( L35L35 )	400				440			
消耗功率W ( L35L50 )	430				470			
冷媒	R134a/360g							
机组运行环境温度°C	0-55							
额定电压V	230							
额定频率Hz	50Hz							
电压范围V	220-240							
换气功能	可选 (注：产品型号后带“-V”的表示该产品有换气功能)							
外形尺寸WxHxDmm	389x954x180							
重量Kg	22				25			
防护等级	IP54							
噪音等级	55dB(A)							
安装方式	半内嵌安装		无螺钉卡装		半内嵌安装		无螺钉卡装	

TCS680/825/680Q/825Q外形图:

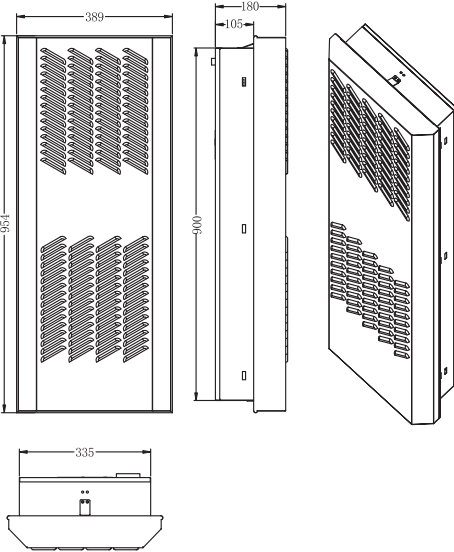

TCS680/825  
安装开孔图:

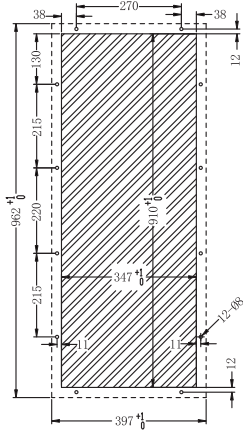

TCS680Q/825Q  
安装开孔图:

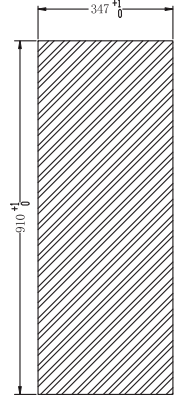

项目	TCS1100				TCS1500			
	TCS1100/1100-V		TCS1100Q/1100Q-V		TCS1500/1500-V		TCS1500Q/1500Q-V	
订货号	30200580	30200582	30200587	30200597	30200325	30200395	30200588	30200598
制冷功率W ( L35L35 )	1100				1500			
制冷功率W ( L35L50 )	935				1180			
消耗功率W ( L35L35 )	680				750			
消耗功率W ( L35L50 )	760				810			
冷媒	R134a/550g							
机组运行环境温度°C	0-55							
额定电压V	230							
额定频率Hz	50Hz							
电压范围V	220-240							
换气功能	可选 (注：产品型号后带“-V”的表示该产品有换气功能)							
外形尺寸WxHxDmm	453x1100x185							
重量Kg	27				35			
防护等级	IP54							
噪音等级	55dB(A)							
安装方式	半内嵌安装		无螺钉卡装		半内嵌安装		无螺钉卡装	

TCS1100/1500/1100Q/1500Q外形图:

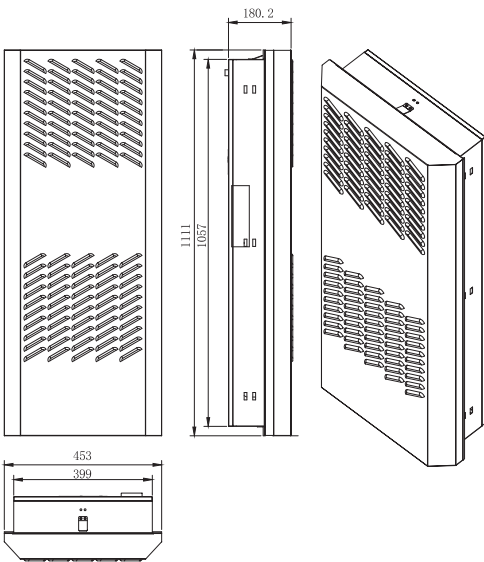

TCS1100/1500  
安装开孔图:

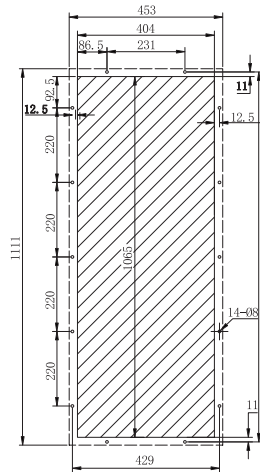

TCS1100Q/1500Q  
安装开孔图:

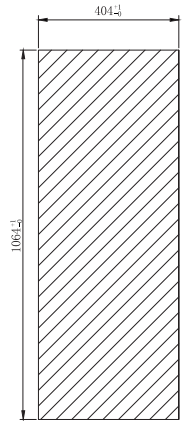

项目	TCS2000				TCS2500			
	TCS2000/2000-V		TCS2000Q/2000Q-V		TCS2500/2500-V		TCS2500Q/2500Q-V	
订货号	30200326	30200396	30200589	30200599	30200327	30200397	30200590	30200600
制冷功率W ( L35L35 )	2000				2500			
制冷功率W ( L35L50 )	1650				2050			
消耗功率W ( L35L35 )	1050				1170			
消耗功率W ( L35L50 )	1230				1390			
冷媒	R134a/550g							
机组运行环境温度°C	0-55							
额定电压V	230							
额定频率Hz	50Hz							
电压范围V	220-240							
换气功能	可选 (注：产品型号后带“-V”的表示该产品有换气功能)							
外形尺寸WxHxDmm	466x1186x300							
重量Kg	46				50			
防护等级	IP54							
噪音等级	55dB(A)							
安装方式	半内嵌安装		无螺钉卡装		半内嵌安装		无螺钉卡装	

TCS2000/2500/2000Q/2500Q外形图:

TCS2000/2500  
安装开孔图:

TCS2000Q/2500Q  
安装开孔图:

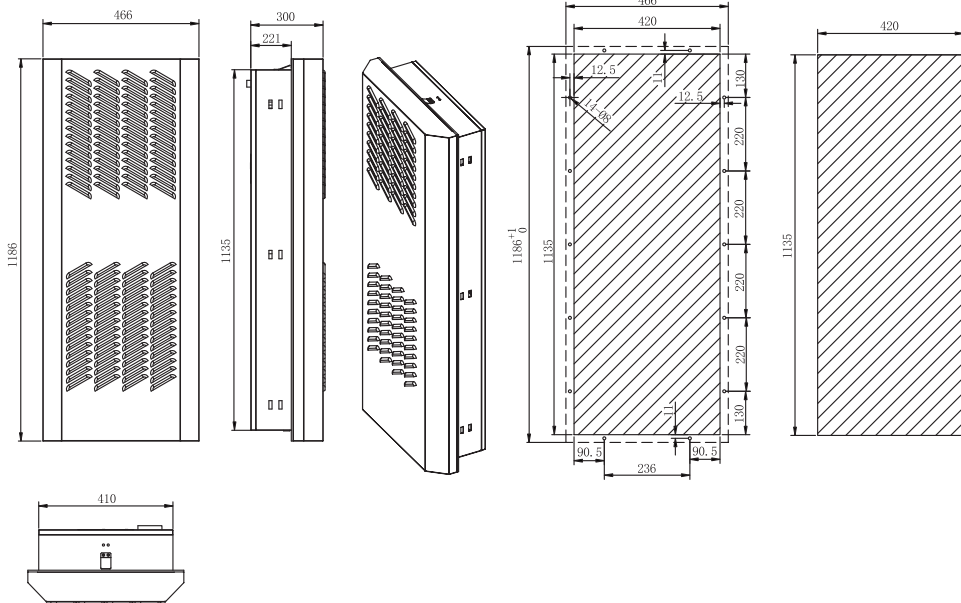

项目	TCS3200				TCS3600			
	TCS3200/3200-V		TCS3200Q/3200Q-V		TCS3600/3600-V		TCS3600Q/3600Q-V	
订货号	30200568	30200570	30200591	30200601	30200569	30200571	30200592	30200602
制冷功率W ( L35L35 )	3200				2500			
制冷功率W ( L35L50 )	2910				3230			
消耗功率W ( L35L35 )	1420				1570			
消耗功率W ( L35L50 )	1760				1940			
冷媒	R134a/1350g							
机组运行环境温度°C	0-55							
额定电压V	230							
额定频率Hz	50Hz							
电压范围V	220-240							
换气功能	可选 (注：产品型号后带“-V”的表示该产品有换气功能)							
外形尺寸WxHxDmm	466x1186x300							
重量Kg	55				60			
防护等级	IP54							
噪音等级	55dB(A)							
安装方式	半内嵌安装		无螺钉卡装		半内嵌安装		无螺钉卡装	

TCS3200/3600/3200Q/3600Q外形图:

TCS3200/3600  
安装开孔图:

TCS3200Q/3600Q  
安装开孔图:

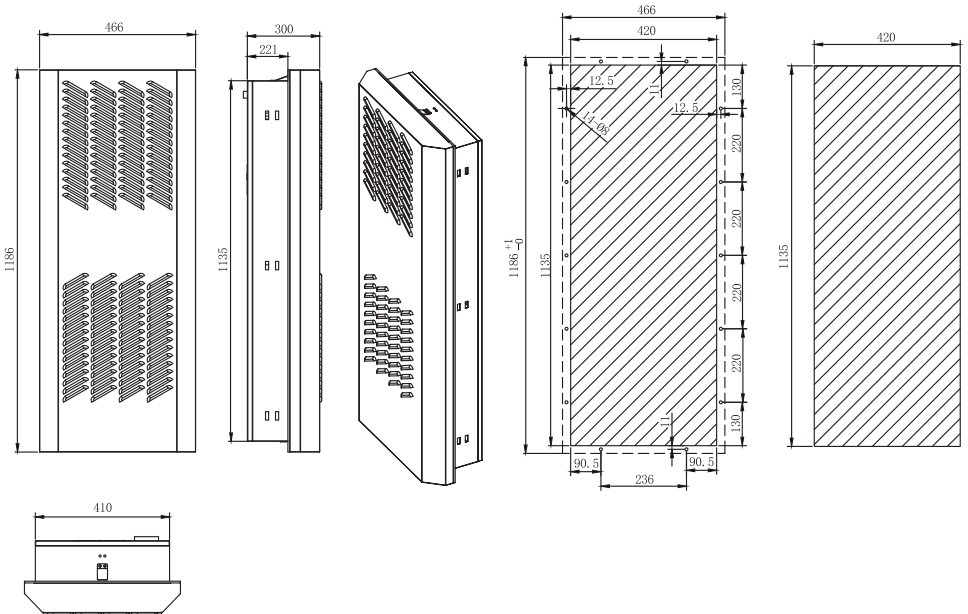

### 3. 安装方式

TCS系列产品每种型号都设计有半内嵌和无螺钉快速卡装（产品型号后缀带Q）两种安装方式，客户可根据需要选择。

### 4. 安全与注意

**安全提示：**制冷机为精密电气，搬运务必轻放，严禁倒置，严禁倾斜存放

**注意事项：**

- ◆ 制冷机在灰尘大、油性或者毛绒的环境务必及时清理过滤网，否则会影响制冷机性能。
- ◆ 制冷机内循环入风口需安装到控制柜体的上部。
- ◆ 控制柜外的温度不能超过55摄氏度，但短暂的高温并不影响制冷机运作。
- ◆ 包装应完好，如果发现制冷机有油渍，极有可能是泄漏制冷剂，包装的任何损坏都有可能引起制冷机的故障。
- ◆ 控制柜必须达到IP54，如果控制柜有漏洞或缝隙，冷凝水可能会持续产生。
- ◆ 制冷机之间或制冷机与墙壁距离不小于200mm。
- ◆ 在控制柜内部，制冷机入风和出风口不可有障碍物阻塞。
- ◆ 制冷机需水平安装、使用，最大倾斜角度不大于2°
- ◆ 维护及送电必须由专业人员操作。
- ◆ 为避免冷凝物的形成，建议采用门位开关，保证当控制柜门打开时，制冷机关闭。
- ◆ 控制柜内部电气元件的热释放不能超过制冷机可用制冷功率，否则会出现制冷机长期运作。
- ◆ 不可用任何方式修改制冷机。

### 5. 电气联接

- ◆ 电压与频率必须与制冷机的铭牌相匹配。
- ◆ 机组外壳必须可靠接地。
- ◆ 在对户外柜测试保护对地电阻，高压和绝缘等级时，制冷机必须与电路断开

### 6. 操作说明

机组通电后控制系统会进行自检，自检结束后（约5秒）内风机自动启动；若满足压缩机启动条件，则外风机和压缩机也一起自动启动。

#### 6.1 常规操作（操作说明设置所需参数）



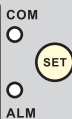
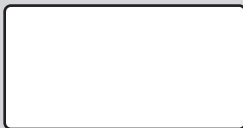

## 注意

在灰尘大、油腻或有毛绒的环境，务必及时清理过滤网，（雷子克建议一个月清理二次）否则会影响制冷机的性能。

## CAUTION

Under the condition of heavy dust, oil or dense fluff, make sure the filter is regularly cleaned (twice per month is suggested); Otherwise the unit performance will be affected.

电气柜环境控制的领先制造商  
leading manufacturer of enclosure climate control units

热线:800-888-1990 400-779-8809  
HTTP://WWW.LEIZIG.COM

控制面板如上图所示

面板指示灯

#COM #通讯指示灯

#ALM #故障指示灯

按键

设定置



向上键



向下键



## 6.2 按键说明

按键	意义	功能
SET	设置	用户参数设置功能，短按一次为查看状态，此时可按“UP”按顺序查看各个设置值，当显示最后一个设置选项时，再按一次“DOWN”键，即返回主页面；查看设置值时再短按一次“SET”即进入设置状态，此时设定值闪烁，按动“UP”或“DOWN”键可增加或减少设定值，再短按一次“SET”键可使设定值立即生效并返回查看状态。
UP	增加	1、在设定参数时，短按此键值递增1，长按此键不放，值快速递增。 2、在查看故障页面，有多个故障时，按“UP”上翻进行查看系统存在的故障。
DOWN	减小	在设定参数时，短按此键值递减1，长按此键不放，值快速递减。

UP+SET	—	查看故障功能：组合键按一次进入查看故障，无故障时，显示“n.55”；有故障时：数码管显示第一个故障代码，有多个故障时，按“UP”下翻进行查看系统存在的故障。再按下“UP+SET”退出故障查询页面，并返回主页面。
SET+UP+DOWN	自检	在开机读秒期间按组合键进入自检
无按键	—	如果不在主页面并30秒内无按键和系统无故障时则系统自动返回主页面。

### 6.3 显示说明

控制板上有三个数码管指示当前机组状态:

机组状态	显示
上电读秒	上电读秒时三个数码管从999~000倒数10秒，提示正在上电，倒数后显示当前柜内温度；远控点短接时，系统关机时数码管闪烁“OFF”，提示正在关机。
开机	主页面显示当前室内温度实时温度，按“UP”或“DOWN”键可切换“室内温度”与“热管温度”显示；显示“热管温度”时，最后一位数码管小数点点亮
设置时	在设置页面，第一位数码管显示设置代码，后二位数码管显示当前设置参数的值。
故障时	弹出故障显示页面，并显示第一个故障代码。

### 6.4 参数设置

1. 在温度显示界面，按SET键出现下面图案,进入制冷温度设定选项,缺省值为35,在按一下SET键,第一个字母闪烁，表示可以对设置值进行设置，通过增加键和减少键进行调整.数据范围为(28-40).在按一下SET键,退出设置值调整。
2. 在温度显示界面，按SET键,在按下减少键，出现下面图案,进入制冷回差设定选项,缺省值为3,再按SET键,第一个字母闪烁，表示可以对设置值进行设置，通过增加键和减少键进行调整.数据范围为(1-9).在按一下SET键,退出设置值调整。



**注：如果10秒内未有任何操作，则放弃当前设定并返回温度显示界面。**

## 6.5 故障报警

根据系统设置，各故障点常闭表示故障点如果和该排插座的DCOM(公共端)形成回路则表示正常，如果断开则表示故障。没有用到的故障点，请将其短接，以免引起不必要的报警。故障报警时，故障指示灯点亮，蜂鸣器发出报警声。故障静音可按增加键。



故障	代码	推迟时间	持续时间	复位操作	备注
柜内温度探头故障	EE1	0秒	2秒	自动	报警、停压缩机
热管温度探头故障	EE2	0秒	2秒	自动	报警、停压缩机
高温报警	EHL	0秒	2秒	自动	报警
热管超温	EdS	0秒	2秒	自动	报警、停压缩机

注：故障复位后压机延时1分钟重新开启，且需满足压缩机停机时间大于[压缩机最短停机时间]；通信故障时，屏记忆通信故障前的屏显示页面

## 7. 工作原理

压缩机把制冷剂压缩到一个更高的压力，进入到冷凝器。在这个过程中冷凝器温度高于环境温度因此得到有效的散热，通过冷凝器的表面对环境的散热后制冷剂变成液态，并通过节流部件，返回到蒸发器，在低温低压条件下蒸发。蒸发所需的热量使户外柜内部造成降温，冷却循环就此完成。上述过程中的传热又循环启动。

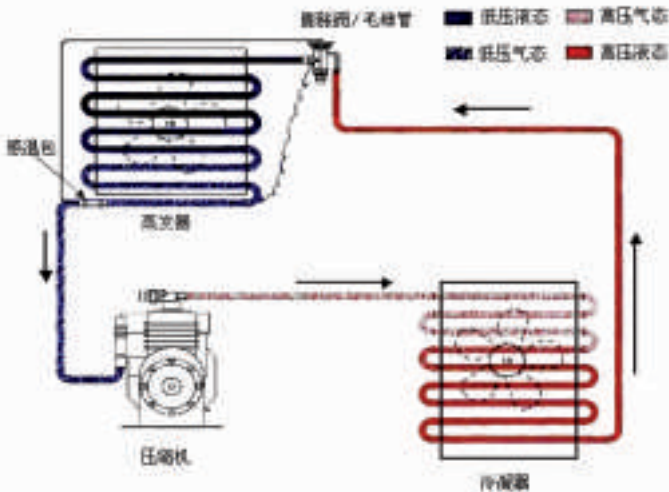

## 8. 维护保养

作为免维护的制冷机，制冷机在出厂前已经过严格的测试，所有的性能参数都通过相应认证，风机采用滚珠轴承，寿命达到三万小时。只有在灰尘大的环境才建议用过滤网，并建议一个月清理至少两次。

长期不使用时请切断电源。

在维护，保养时务必切断电源。

## 9. 质量保证

雷子克所有制冷机在正常使用下（参照4. 安全提示），拥有十五个月的免费维护，在质保期内，返还的制冷机会在厂里或现场免费维修。

制冷机只能用于控制柜的冷却，如果被错误连接电源，或违规操作（参照使用说明书），雷子克无责任承担任何的损失。

## 10. 电气原理图

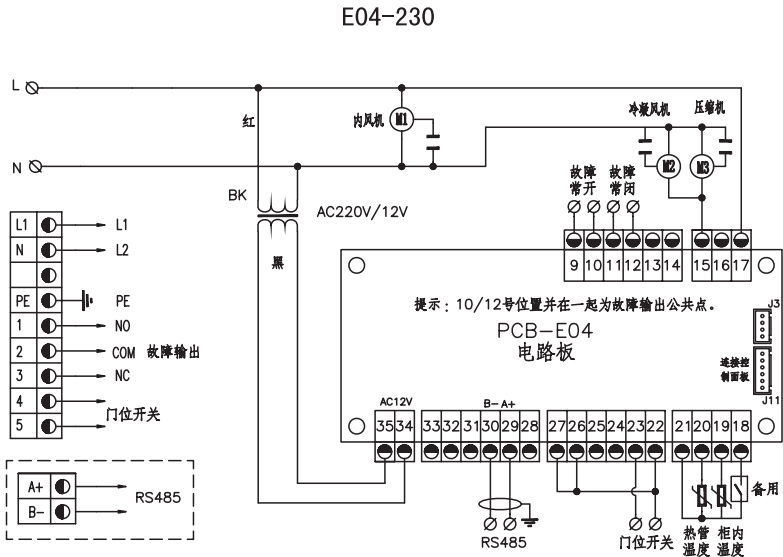

# 11. 常见故障分析及解决措施

故障现象	故障原因	检查方法	解决方法
压缩机无法启动	电源电压不正常	检查电源电压是否符合该机组的标准	调整供电电源 电压及输出的容量
	接触器故障	检查接触器线圈是否烧坏	更换接触器
	温控器失灵	把温控器温度值调到最低,然后检查触点是否接通	如果不能接通,进行更换;如果能接通可调整温控器的精准度
	过热保护器烧坏	检查是否接通	不能接通进行更换
	电容老化	检查电容是否有充放电能力	更换电容
	控制板出现程序错误	通过观察显示板可以判断出(显示错乱代码)	查明原因后更换
系统高压报警	冷凝器过脏	检查冷凝器内部铜管是否太脏	清洗冷凝器
	系统内有不凝结的气体	检查排气温度及压力是否正常	重新抽真空 加注冷媒
	冷凝风机过滤网脏堵	检查过滤网是否堵塞	清洗过滤网
	冷凝风机不启动	检查风机(电容)是否烧坏	进行更换
压缩机及两风机都正常运行但不制冷	系统冷媒泄漏	对系统进行检漏	检漏,补漏,保压,抽真空,充注冷媒后试机(请与厂家联系)
	系统脏堵	检查干燥过滤器外部是否结冰	更换干燥过滤器 保压 抽真空 充注冷媒后试机请与厂家联系)
空调启动后导致空气开关跳闸	断路器故障(使用不当)	检查断路器容量是否使用过小	选用的断路器容量电流要比空调的运行电流大1.5倍
	压缩机故障	检查压缩机绕组绝缘 对地绝缘是否损坏	请与厂家联系
	冷凝风机故障		
	蒸发风机故障	检查风机绕组绝缘 对地绝缘是否损坏	
制冷效果差	冷凝风机过滤网脏堵	检查过滤网是否堵塞)	
	系统泄漏	1.使用检漏仪进行检漏 2.可用测量电流判断	请与厂家联系
	系统脏堵	检查干燥过滤器外部是否结冰	更换干燥过滤器 保压 抽真空 充注冷媒后试机请与厂家联系)

## Content

1. Application
2. Technical data and cutout drawing
3. Assembly
4. Safety and caution
5. Electrical connection
6. Regular operations
7. Working principle
8. Maintenance/care
9. Quality warranty
10. Electrical schematic diagram
11. Common faults and troubleshooting

# 1. Application

Leizig TCS cooling unit is specifically designed to cool the outdoor cabinet.

It protects the inside costly components sensitive to temperature by dispersing heat load out of the cabinet and is particularly suitable for the condition under the temperature range from 0°C to 55°C, with the effect surpassing other heat dissipation items such as air/air heat exchanger and filter fan unit.

# 2. Technical data and cutout drawing

Model# col.	TCS320				TCS500			
	TCS320/320-V		TCS320Q/320Q-V		TCS500/500-V		TCS500Q/500Q-V	
ID#	30200358	30200382	30200583	30200593	30200579	30200581	30200584	30200594
cooling output W(L35L35)	320				500			
cooling output W(L35L50)	240				400			
power consumption W(L35L35)	240				300			
power consumption W(L35L50)	270				340			
refrigerant	R134a/360g							
Ambient temperature°C	0-55							
rated voltageV	230							
rated frequencyHz	50Hz							
Range of operationV	220-240							
Air exchange function	Optional:(The model suffixed with "V" is the type built-in with air exchange function.)							
DimensionWxHxDmm	300x560x155							
weight Kg	16				18			
Protection category	IP54							
Noise level	52dB(A)							
Fitting	semi-recessed		boltless		semi-recessed		boltless	

TCS320/500/320Q/500Qdimension drawing:

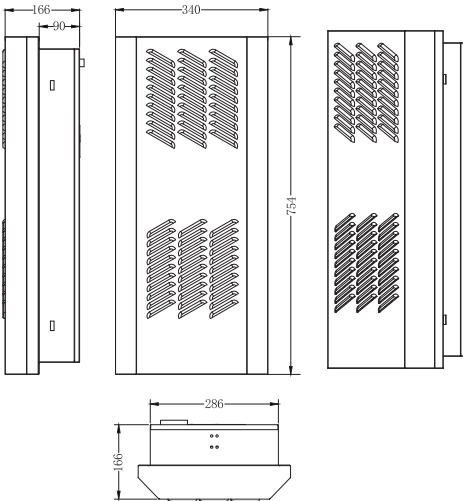

TCS320/500 cutout drawing:

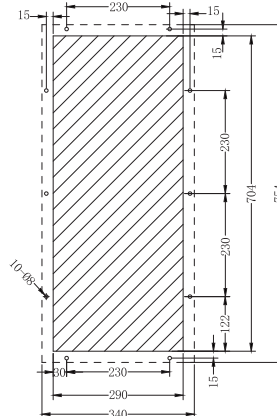

TCS320Q/500Q cutout drawing:

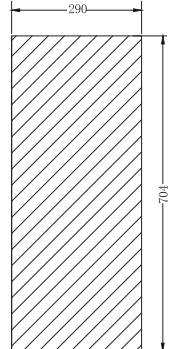

col.	Model#	TCS680				TCS825			
		TCS680/680-V		TCS680Q/680Q-V		TCS825/825-V		TCS825Q/825Q-V	
ID#		30200357	30200393	30200585	30200595	30200572	30200573	30200586	30200596
cooling output W(L35L35)		680				825			
cooling output W(L35L50)		560				680			
power consumption W(L35L35)		400				440			
power consumption W(L35L50)		430				470			
refrigerant		R134a/360g							
Ambient temperature°C		0-55							
rated voltageV		230							
rated frequencyHz		50Hz							
Range of operationV		220-240							
Air exchange function		Optional:(The model suffixed with "V" is the type built-in with air exchange function.)							
DimensionWxHxDmm		389x954x180							
weight Kg		22				25			
Protection category		IP54							
Noise level		55dB(A)							
Fitting		semi-recessed		boltless		semi-recessed		boltless	

TCS680/825/680Q/825Qdimension drawing:

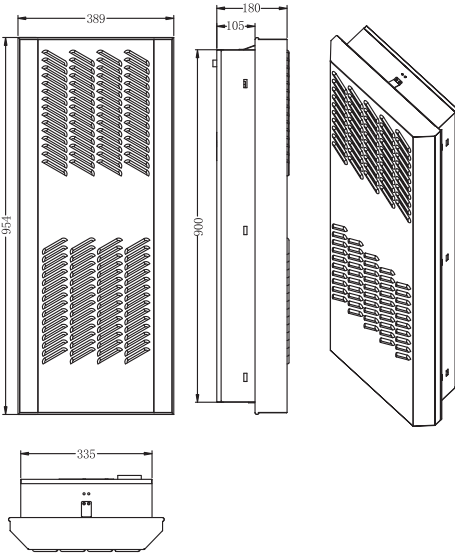

TCS680/825  
cutout drawing:

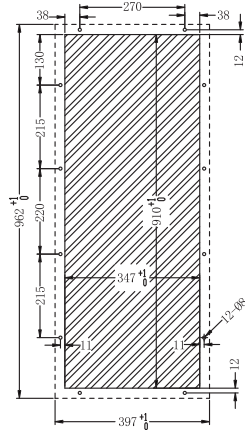

TCS680Q/825Q  
cutout drawing:

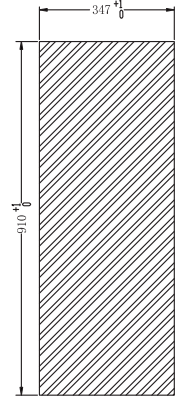



col. Model#	TCS1100				TCS1500			
	TCS1100/1100-V		TCS1100Q/1100Q-V		TCS1500/1500-V		TCS1500Q/1500Q-V	
ID#	30200580	30200582	30200587	30200597	30200325	30200395	30200588	30200598
cooling output W(L35L35)	1100				1500			
cooling output W(L35L50)	935				1180			
power consumption W(L35L35)	680				750			
power consumption W(L35L50)	760				810			
refrigerant	R134a/550g							
Ambient temperature°C	0-55							
rated voltageV	230							
rated frequencyHz	50Hz							
Range of operationV	220-240							
Air exchange function	Optional:(The model suffixed with "V" is the type built-in with air exchange function.)							
DimensionWxHxDmm	453x1100x185							
weight Kg	27				35			
Protection category	IP54							
Noise level	55dB(A)							
Fitting	semi-recessed		boltless		semi-recessed		boltless	

FCC1100/1500/1100Q/1500Q dimension drawing:

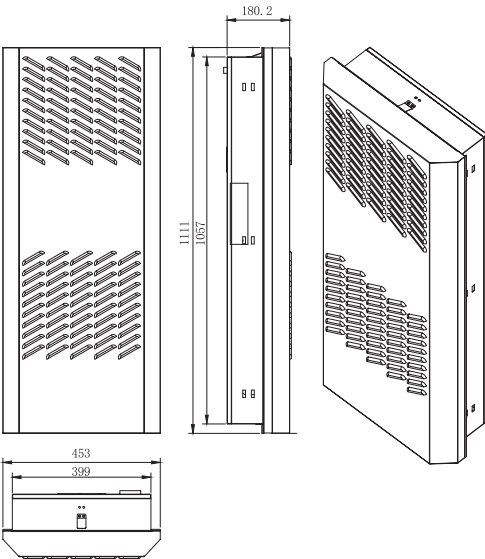

TCS1100/1500  
cutout drawing:

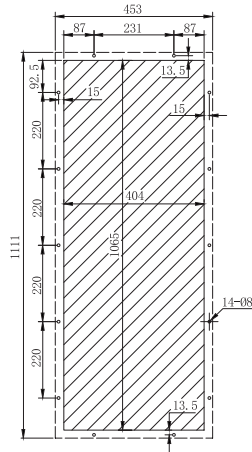

TCS1100Q/1500Q  
cutout drawing:

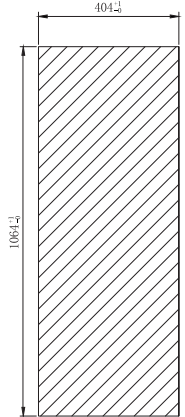

Model# col.	TCS2000				TCS2500			
	TCS2000/2000-V		TCS2000Q/2000Q-V		TCS2500/2500-V		TCS2500Q/2500Q-V	
ID#	30200326	30200396	30200589	30200599	30200327	30200397	30200590	30200600
cooling output W(L35L35)	2000				2500			
cooling output W(L35L50)	1650				2050			
power consumption W(L35L35)	1050				1170			
power consumption W(L35L50)	1230				1390			
refrigerant	R134a/550g							
Ambient temperature°C	0-55							
rated voltageV	230							
rated frequencyHz	50Hz							
Range of operationV	220-240							
Air exchange function	Optional:(The model suffixed with "V" is the type built-in with air exchange function.)							
DimensionWxHxDmm	466x1186x300							
weight Kg	46				50			
Protection category	IP54							
Noise level	55dB(A)							
Fitting	semi-recessed		boltless		semi-recessed		boltless	

TCS2000/2500/2000Q/2500Q dimension drawing:

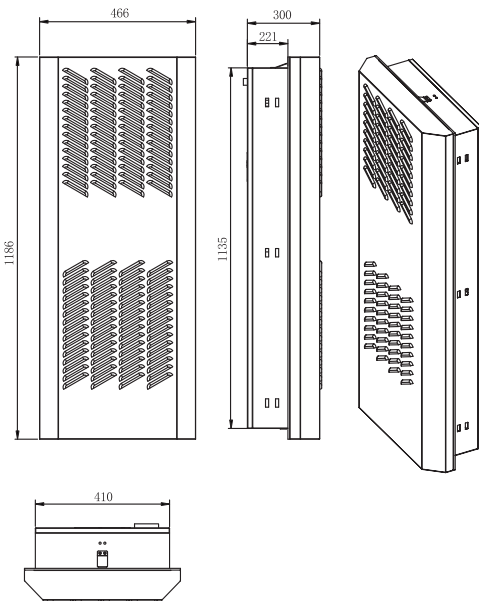

TCS2000/2500 cutout drawing:

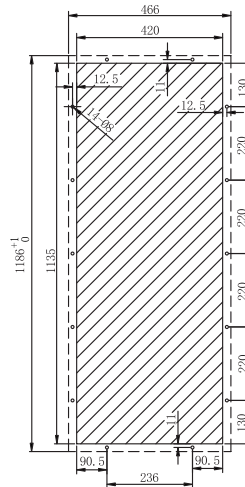

TCS2000Q/2500Q cutout drawing:

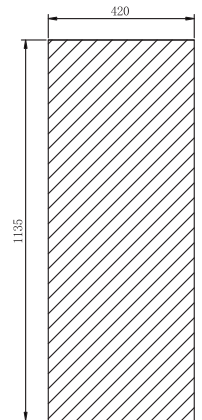

Model# col.	TCS3200				TCS3600			
	TCS3200/3200-V		TCS3200Q/3200Q-V		TCS3600/3600-V		TCS3600Q/3600Q-V	
ID#	30200568	30200570	30200591	30200601	30200569	30200571	30200592	30200602
cooling output W(L35L35)	3200				3600			
cooling output W(L35L50)	2910				3230			
power consumption W(L35L35)	1420				1570			
power consumption W(L35L50)	1760				1940			
refrigerant	R134a/1350g							
Ambient temperature°C	0-55							
rated voltageV	230							
rated frequencyHz	50Hz							
Range of operationV	220-240							
Air exchange function	Optional:(The model suffixed with "V" is the type built-in with air exchange function.)							
DimensionWxHxDmm	466x1186x300							
weight Kg	55				60			
Protection category	IP54							
Noise level	55dB(A)							
Fitting	semi-recessed		boltless		semi-recessed		boltless	

TCS3200/3600/3200Q/3600Q dimension drawing:

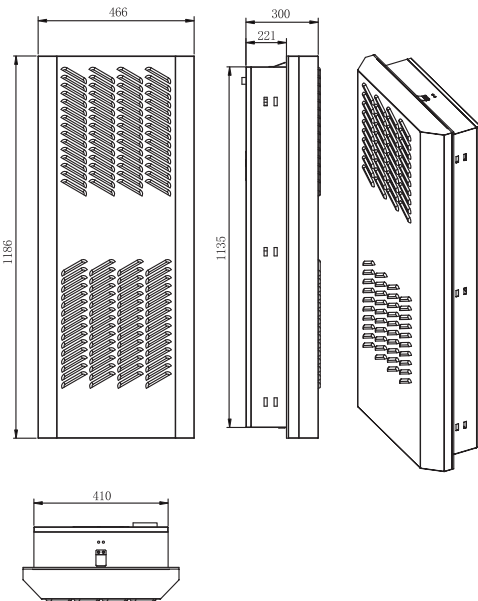

TCS3200/3600  
cutout drawing:

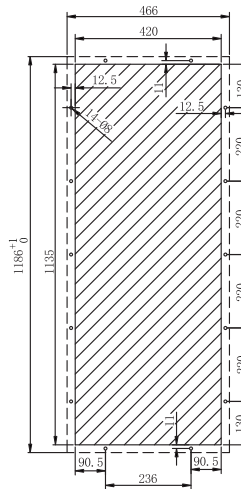

TCS3200Q/3600Q  
cutout drawing:

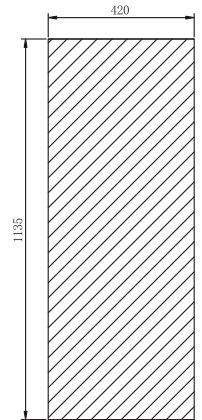

### 3.Assembly

Each model of TCS series item is devised with 2 fitting methods: semi-recessed or boltless with fast clip(ending Q) on request .

### 4.Safety and caution

**Safety warning:**cooling unit is a kind of precise electrical device, thus please put in down gently, do not bottom it up or recline it in transportation and storage.

**Cautions :**

- ◆ Clean the filter mesh regularly in the dusty, oily or plush environment; otherwise the performance may be impacted;
- ◆ The inlet opening of cooling unit should be located on the top of enclosure;
- ◆ The temperature surrounding the enclosure shall not exceed 55 degree Celsius and transient high temperature will not affect the function of cooling unit;
- ◆ The packaging shows no signs of damage. Oil stains or damaged packaging is an indication of refrigerant loss and of leakage in the unit system. Any damage to the packaging may be the cause of subsequent malfunctions;
- ◆ The protection grade of enclosure must be up to IP54; the condensate may form in case of any gaps or openings at the enclosure walls;
- ◆ The distance between 2 units or that away from the wall should not be less than 200 mm;
- ◆ Air inlet and outlet are not obstructed inside enclosure;
- ◆ Units should only be fitted horizontally in the specified position. Max. deviation from true Horizontal: 2°;
- ◆ Maintenance and power transmission must be operated by the professional person;
- ◆ To avoid an increase on condensation, a door operated switch should be used which will switch off the cooling unit when the enclosure door is opened;
- ◆ The heat loss load from inside components should not exceed the rated cooling capacity of the unit;
- ◆ The customer must not modify the design or configuration of cooling unit in any way.

### 5. Electrical connection

- ◆ The voltage and frequent in use must match the data stated in the rating plate of cooling unit;
- ◆ The housing of unit must be reliably wired with earth;
- ◆ Power must be cut down to test the PE resistance, high voltage and insulation grade of outdoor cabinet.

## 6. Regular operations

After the unit is electrified, the control system will carry out the self-diagnosis within 5 seconds , then the internal fan starts; if the condition of compressor start-up is satisfied, both the external fan and compressor will run automatically together.

### 6.1 Ordinary operation ( parameters setting )



**Leizig 雷子克**  
Enclosure Climate Technologies

### 注意

在灰尘大、油腻或有毛绒的环境，务必及时清理过滤网，(雷子克建议一个月清理二次)否则会影响制冷机的性能。



### CAUTION

Under the condition of heavy dust, oil or dense fluff, make sure the filter is regularly cleaned(twice per month is suggested); Otherwise the unit performance will be affected.

电气柜环境控制的领先制造商  
leading manufacturer of enclosure climate control units

热线:800-888-1990 400-779-8809  
HTTP://WWW.LEIZIG.COM

See the control panel at above picture

#### Panel indicator lights

# COM # Communicating indicator light

# ALM # Fault indicator light

#### Keys

Set key

Increase(Incr.) or turn up Key

Decrease(Decr.) or turn down key



### 6.2 Key-press guidance

Symbol	Role	Function
SET	Set	For user's parameter setting , check the status by a short press and press "UP" to look up the set value; When the display is for the last selection , repress "DOWN" to revert to the main menu; In the course of set value reading , another short press of "SET" gets into setting process , when the setting value is flashing , press "UP" or "DOWN" to increase or decrease the value , then validate it and return to lookup status by a short press of "SET" again.
UP	Incr.	<ol style="list-style-type: none"> <li>.In setting interface , a short press makes the value increased progressively 1 by 1 and a long press gets the rapid increment.</li> <li> In the interface of fault lookup , press "UP" to leaf through the defaults with the system</li> </ol>

<b>DOWN</b>	Decr.	In setting interface,a short press makes the value decreased progressively 1 by 1 and a long press it rapidly diminished
<b>UP+SET</b>	—	A lookup of default: press the combined keys once to look up the fault; if there is no fault , the interface displays"r.55"; if the malfunction occurs , the Nixie tubes read the 1st code; in case of many defaults , press "UP" orderly to check all the breakdowns ; then press "UP+SET" to quit the and turn to the main interface.
<b>SET+UP+DOWN</b>	Self diagnosis	Enter into the self-diagnosis by pressing the combined keys in the period of startup countdown
<b>No press</b>	—	The system will return to the main interface if there is no operation on the keys in 30 s and no faults found

### 6.3 Display guidance

The 3 Nixie tubes on the control panel indicates the present operating condition of the unit:

<b>Use condition</b>	<b>Display</b>
Countdown of electrification	The 3 Nixie tubes of a range from 999 to 000 count down by 10s to reveal the unit is being electrified , then it enters into the display of current "Cabinet inside temperature"; if the remote control points are short circuited , it will show the unit is closing down.
Startup	In the main interface, it shows the real-time indoor temperature, press "UP" or "DOWN" to switch to the "Indoor temperature" display.
Setting	In the setting interface , the 1st Nixie tube displays the setting codes , the next 2 digits of tubes display the current values to set.
Fault	The fault interface pops up and displays the first fault code.

### 6.4 Parameter setting

1. In the temperature readout interface , press "SET" to get the cooling temperature setting option as right picture shows , the default value is 35 , repress once "SET" , the first letter flickers to denote the setting is available , then adjust the value (ranging from 28 to 40) through the key "UP" or "DOWN"; press " SET" another time to quit the value adjustment.



2. In the temperature readout interface, press "SET" and subsequently "DOWN" to get the setting option of the cooling return differential, the default value is 3, repress once "SET", the first letter flickers to denote the setting is available, then adjust the value (ranging from 1 to 9) through the key "UP" or "DOWN"; Press "SET" another time to quit the value adjustment



**N.B. : If no any manipulation occurs within 10 seconds , it will quit the current setting and get back to the temperature display interface.**

## 6.5 Failure alarm

In accordance with the system setting , the point in N.C. indicates the failure point; If the return circuit can be formed between the DCOM(common port) of the plug and the point , it will run in no problem; on the contrary , the disconnection means failure. For the points in no use , short-circuit it to avoid the unwanted alarms. In case of fault , the indicator light is on and there is alarm from the speaker. Press "UP" to mute it.



Fault	Code	Delay	Duration	Reset	Remarks
Inside enclosure temperature probe fault	EE1	0 s	2 s	Auto.	Alarm,Compressor halt
Heat pipe temperature probe fault	EE2	0 s	2 s	Auto.	Alarm,Compressor halt
High temperature Alert	EH1	0 s	2 s	Auto.	Alarm
Heat pipe over-temperature	Ed5	0 s	2 s	Auto.	Alarm,Compressor halt

**N.B. :** The compressor will restart in 1 min. delay after the reset of compressor and the downtime of compressor is larger than the shortest halt time. In case of communication malfunction,he display will keep in memory the interface before the fault.

## 7. Working principle

The cooling unit applies the theory of phase-transition cooling this way: the gaseous refrigerant is expelled out of the compressor, in high temperature and high pressure, enters into condenser, cooled forcibly and liquefied in modest temperature and still high pressure, then goes through the throttling devices such as capillary or expansion valve to become liquid in lower temperature and lower pressure when it flows into evaporator, afterwards, it returns to the condenser by phasechange absorbing the heat of inside enclosure. This reciprocating circulation guarantees the reliable working environment.

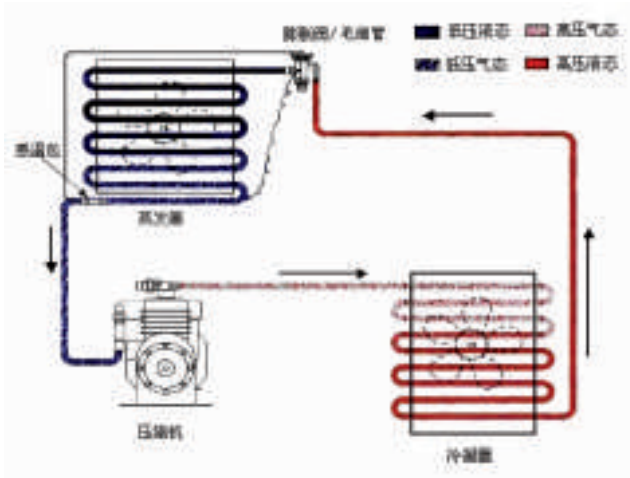

## 8. Maintenance/care

As the maintenance-free cooling device, the unit has been strictly tested before ex. Factory and all performance passed the international certification. The fan of ball bearing has a lifespan up to 30, 000 hour. The filter mesh is recommended to use in case of dense dusts and clean at twice every month.

Turn off the power if the cooling unit is kept long not for use.

The power must be switched off in the period of maintenance/care.

## 9. Quality warranty

All the cooling units in normal use (Refer to 4. Safety notes) shall be granted with a year of free maintenance. During the valid warranty, the faulty unit will be returned to factory or handled on the site for repairs.

The product is only limited to the purpose of cooling down the enclosure; otherwise Leizig shall take on no responsibility for the losses caused by any misconnection to power or incorrect operations (see regular operations). Electrical circuit drawings.



# 10. Electrical diagram

E04-230

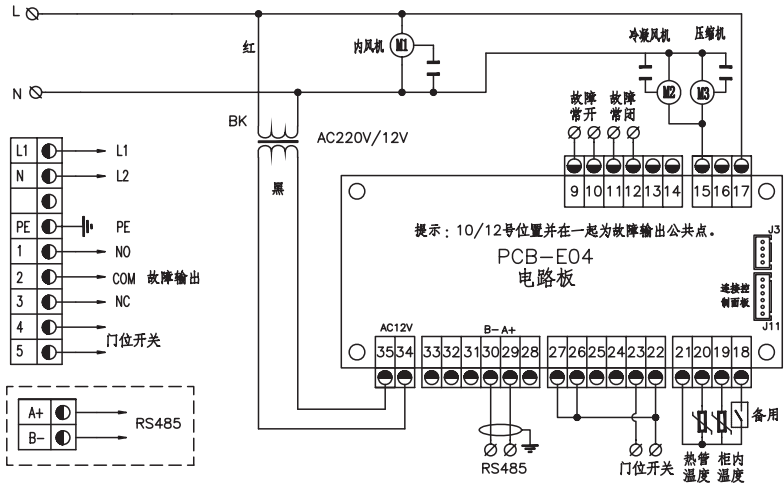

# 11. Common faults and troubleshooting

Faults	Probable cause	Diagnosis method	Troubleshooting
Compressor not working	abnormal voltage	check if the power matches the stated standard	Adjust the capacity of mains power supply, voltage and output
	contacter fault	check the coils of contactor if they are burnt out	Replace the contactor
	thermostat malfunction	adjust the thermostat to the lowest and check if contact can be connected	replace it in case of disconnection; or adjust its accuracy in case of connection
	overheat protector burnout	check if it can be connected	replace it in case of disconnection
	capacitor aging	check if capacitor has electro-discharging ability	replace the capacitor
	Program error on control panel	observe the display panel for the error codes	replace it after cause clarification
System high pressure alarm	condenser dirt	check the dirt in the inner copper tube of condenser	clean the condenser
	incondensable air in system	check if outlet temperature and pressure is normal	refill the refrigerant after vacuumization
	condenser fan filter mesh dirt blockage	check if the filter mesh is clogged	clean the filter mesh
	condenser fan no startup	check if the fan(capacitor) is burnt out	replace the capacitor
Compressor +2 fans working but not cooling	Refrigerant leakage	system leakage inspection	test and mend the leakage, pressurize and vacuumize it and contact manufacturer for commissioning it after refrigerant refilling.
	dirt blockage	check if the filter dryer is iced up	replace filter dryer, pressurize and vacuumize it and contact manufacturer for commissioning it after refrigerant refilling.
air switch tripping after AC startup	breaker malfunction (wrong use)	check if the breaker is too small in fuse capacity	The capacity of breaker selected should be 1.5 of AC working current
	compressor malfunction	check if the insulation of compressor coils and earthing are damaged	Contact the manufacturer
	compressor fan malfunction		
	evaporator fan malfunction	check if the insulation of fan and earthing are damaged	
Weak cooling	condenser fan filter mesh dirt blockage	check if the filter mesh is clogged	clean the filter mesh
	system leakage	1. test the leakage 2. measure the current	Contact the manufacturer
	system dirt blockage	check if the filter dryer is iced up	replace filter dryer, pressurize and vacuumize it and contact manufacturer for commissioning it after refrigerant refilling.



# 6 大系列产品



## ■ 通风系列

(过滤风扇, 出口过滤器)



## ■ 制冷系列

(工业电气柜制冷机, 屏柜制冷器, 半导体制冷器)



## ■ 热交换系列

(气气, 水气, 水水, 热交换器核心体)



## ■ 加热系列

(屏柜加热器, 机舱加热器, 温/湿/温湿度控制器)



## ■ 照明系列

(控制柜照明系统, 机舱照明系统)



## ■ 再冷却系统

(再冷却系统, 变流器冷却系统)



### 中国厂址:

中国·广州·白云·人和·江人三路383号·雷子克工业园  
Tel: +86 20 61139230/86456175  
Fax: +86 20 86450613/86456193  
Pos: 510470

### 印尼分公司 PT.LEIZIG Indonesia

Add : Ruko gunung Sahari B3 Jalan gunung Sahari raya no.7 B3  
Kel.Gn Sahari utara Kec.Sarah besar Jakarta pusat ;  
Tel : +62 21 62307778 Fax : +62 21 6242305

### 香港分公司 LEIZIG (HONG KONG) CO.,LIMITED

香港新界葵涌昌路26-38號豪華工業大廈23樓B07室  
Flat B07 Floor23,Hover Industrial Building,NO.26-38 Kwal Cheong  
Road,N.T,HONG KONG.

### 沈阳办事处

沈阳市和平区南京南街1甲联营大厦12楼1203A室 邮编:110001  
Tel: 024-23286090 Fax: 024-23286879

### 北京办事处

北京市朝阳区东三环南路58号富顿中心C座1111室 邮编:100022  
Tel: 010-58674648 Fax: 010-58673438

### 上海办事处

上海市宝山区一二八纪念路878弄968号万达广场1号楼815 邮编:200435  
Tel: 021-51098893, 50496986 Fax: 021-50496987

### 武汉办事处

武汉市武昌区武珞路456号新时代商务广场310房 邮编:430077  
Tel: 027-87739759 / 87739760 Fax: 027-87739736

### 重庆办事处

重庆市江北区观音桥建新南路1号中信大厦23-6 邮编:400020  
Tel: 023-67851609 Fax: 023-67852033

### 福州办事处

福建省福州市台江区五一中路75号友精大厦15F1212 邮编:350000  
Tel: 0591-83324546 Fax:0591-83325725

### 南宁办事处

南宁市新民路4号华星时代广场雅仕阁1816号 邮编:545000  
Tel: 0771-2022453 Fax: 0771-2022453

### 广州办事处

广州市天河区林和西路167号 威尼国际酒店829 邮编:510610  
Tel: 020-61135589 Fax: 020-86450775

### 深圳办事处

深圳市南山区桃园路1号西海明珠商务公寓E座1603 邮编:518052  
Tel: 0755-61280133 Fax: 0755-86193119

客户支持热线:

**800-888-1990**  
**400-779-8809**

HTTP://WWW.LEIZIG.COM

©2013雷子克(中国)有限公司版本所有。未经版本所有人事先许可,本刊的任何部均不得用于商业用途,或被复制、存储至另一个检索系统,或以任何形式或通过任何手段,无论是电子、机械手段还是影印、记录或其它方式进行传播。

版权所有,未经许可不得翻印

如有改动,恕不另行通知,最终解释权归本公司所有